

Alternative Option for Conversion Cable

Itaru Nakagawa, Takashi Hachiya, and Yasuyuki Akiba

Coarse Cost Estimate for Production



Straight Conversion (20cm + 40cm) x 20 cables
Total \$57k in 2019.

The initial cost (design, mask, fixtures) was \$25k for two different design. This translates \$125k per 1 design.

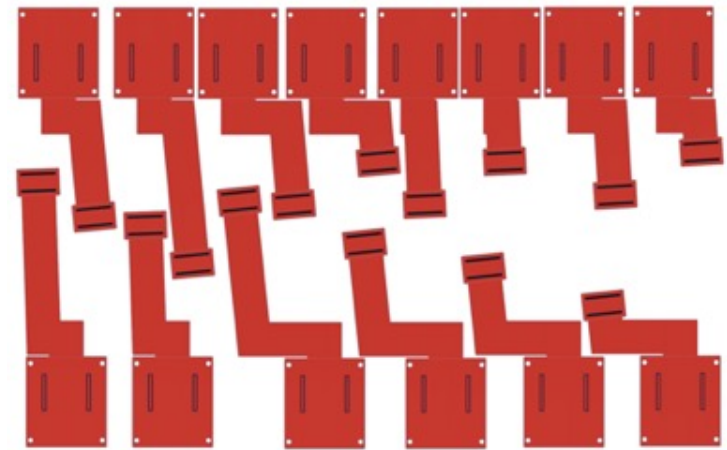

Scaled from the 2019 case, the initial cost for 14 different design will be \$0.2M. The production cost of 10 cables for each design will be **\$0.4M** or so. This is almost similar to the production cost for the bus extender or even more expensive. I am afraid it won't fit within the RBRC budget. My request was \$0.2M for the conversion cable to RBRC budget.

This is quite unfortunate, but we may need to consider possible options.

Boundary Conditions

Pitch=400um

DF18 Connector

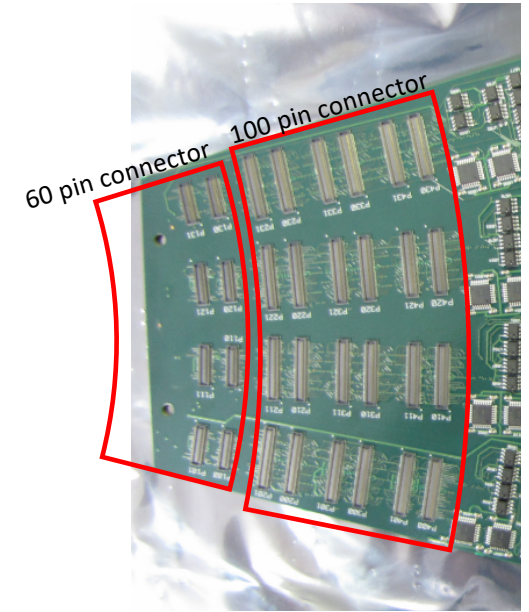
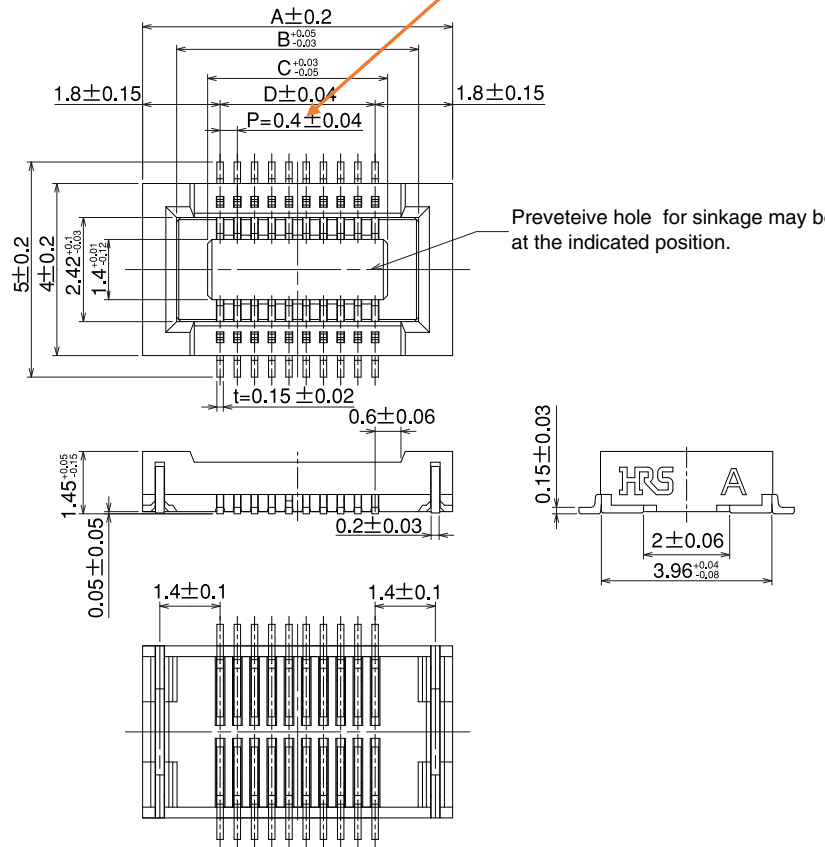

ROC Ports

The DF18 connector's pitch is 400um and very small. This small pitch constrains pitch size of the conversion cable. Ideally, the pitch would be smaller than 400um.

Technology Choices

FFC option as a bus-extender for the beam test

- Consider FFC (Flexible Flat Cable) for the beam test
 - This is a test of option B for the INTT bus-extender

- FFC
 - Impedance controlled FFC ~1m
 - 500um pitch 50lines: Need 4 FFCs for 200lines
 - Cable width = 2.5cm
 - It is cheap and available in the market
 - Less-dense, larger size, heavier

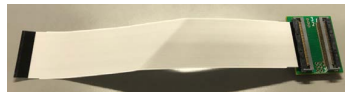

- Conversion board
 - Convert the connector types and make the density less
 - Rigid PCB w/ impedance control
 - Small size (5x5cm)
 - 7 layers same as FVTX bus-extender (2 signal layers, 3 solid layers, 2 surface)



1. Flexible Print Cable (FPC)
2. Flat Flexible Cable (FFC)
3. Micro-Coaxial Cable (MCC)

	FPC	FFC	MCC
Line Pitch [um]	60	500	250
Shield	Shielded	Not Shielded	Shielded
Flexibility	2D	2D	3D

Advantage in the flexibility

1. No flexibility in left/right resulted in multiple different designs.

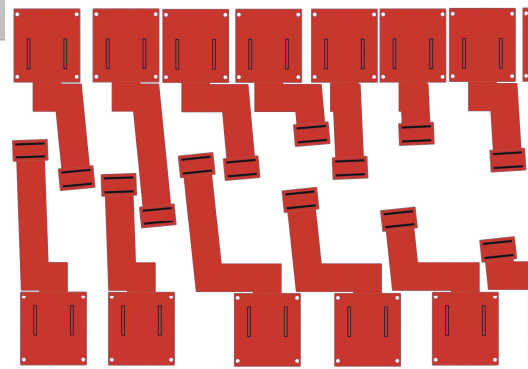

Micro-coaxial cable

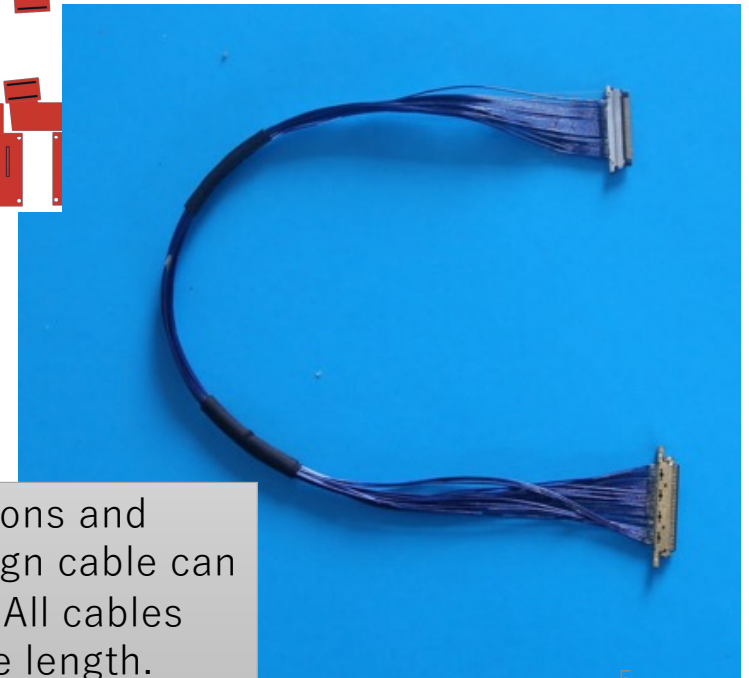

2. Flexible in 3 dimensions and thus only 1 simple design cable can connect any ROC port. All cables can be made in 1 single length.

Potential Risk?

- Coaxial Cable

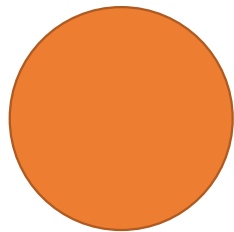

40 ~ 50 μm

Cross section $S = 1256 \sim 1962 \mu\text{m}^2$

- FPC

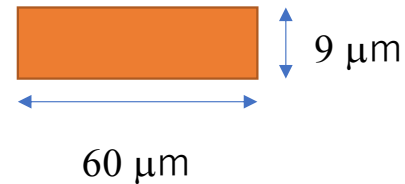

Cross section $S = 540 \mu\text{m}^2$

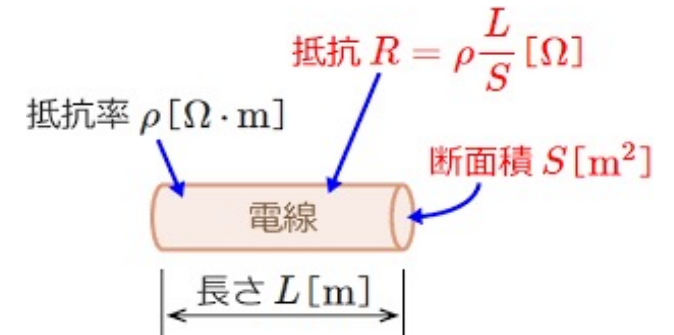

Factor of 2 to 3 larger cross section compared to FPC. Things are not complicated, but the signal attenuation can be expected to be relaxed intuitively.

少なくともベースラインは信号伝送はより難しくなる訳ではなさそう。

高周波信号減衰と表皮効果(1)

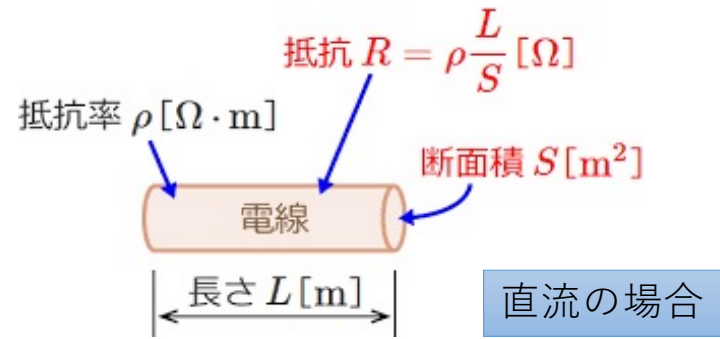
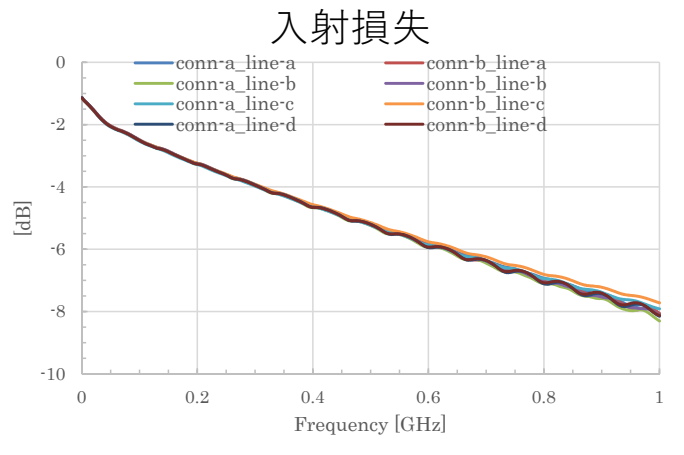

高周波電流は、導体を流れるとき表皮効果が発生し、導体の表面を流れる特性がある。

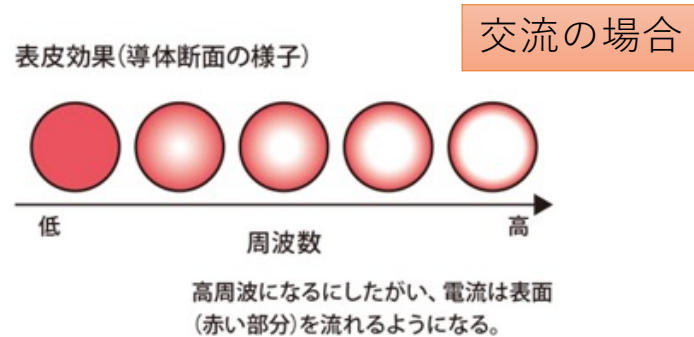

<http://kojo-seiko.co.jp/products/forcebarep.html>

高周波信号減衰と表皮効果(2)

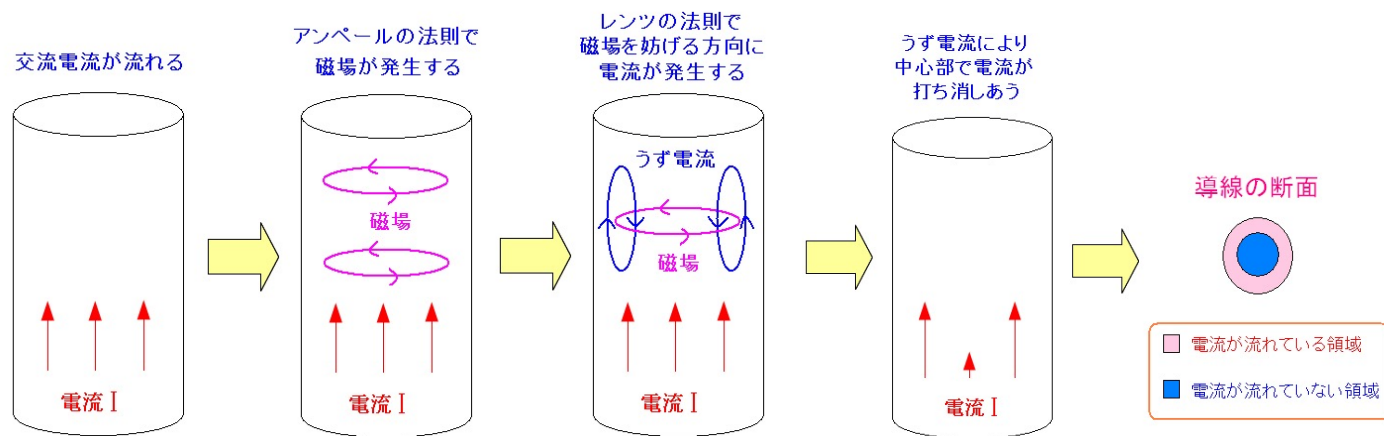

交流電流の場合、プラスとマイナスが交互になる。プラスになって電流が流れはじめるとする。電流が流れ始めた事により、電流の周囲に磁場が発生する。アンペールの法則より。磁場が急に発生するため、磁場の発生を抑制する方向にうず電流が発生する（レンツの法則）。

うず電流が中心部の電流を打ち消してしまうため中心部には電流が流れなくなるという事なのだ。周波数を高くすれば、磁場の変化が激しくなりその分、うず電流の電流量も増え、打ち消す度合いが大きくなるのだ。

Micro-Coaxial Cable



Industry-leading small and thin connectors



Connector for Micro Coaxial Cable

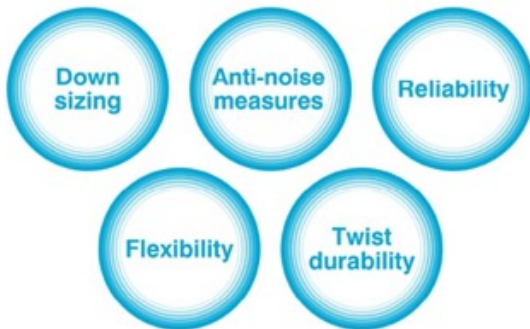

This series of connectors provide best solution for those who face some challenges in downsizing, anti-noise measures, and reliability, as well as those seeking for a cable with superior flexibility and twist durability.

Grounding of PCB Side Connectors

Each series also provided with a ground terminal, metal shell cover and the bottom shell cover is has become a form surrounding the connector, we have to ensure the noise measures and product strength.

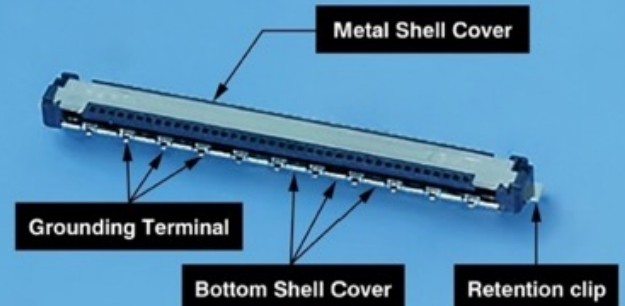

Micro Coaxial Cable Structure

In spite of the extremely thin cable, one by one has become in coaxial structure, and excellent transmission characteristics. Has a high flexibility and twist durability, repeated bending, is the cable that was blessed with strong features to twisting.

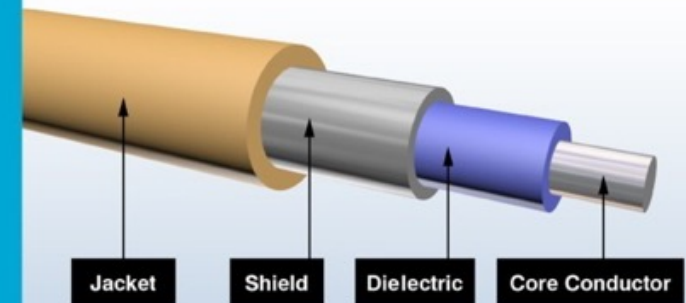

Smallest Pitch Model in KEL

XSL series

Extra-fine coaxial cable type 

0.25mm pitch extra-fine coaxial cable connector

[Features](#) | [specification](#) | [Download materials](#) | [Product list / technical data](#)

[Contact & Support](#)

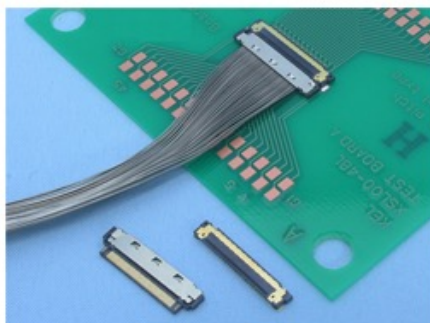

The "XSL series" connector for 0.25 mm pitch micro coaxial cable, and is the industry's smallest level product.

■ Micro coaxial cable

The micro coaxial cable is good at transmission characteristics and the very thin cable has high bending flexibility, so it could connect between PCBs within a small device with a high degree of freedom and the bundle of the cables can pass through a thin hinge part. Micro coaxial cable is small and has good transmission characteristics, there is a wide range of needs from products that require miniaturization and high functionality.

We have been actively developing connector for micro coaxial cables.

Features of connector for micro coaxial cable

Our micro coaxial cable connector is designed to maintain the transmission characteristics that are the characteristics of coaxial cables at the point of connector.

This series improves the transmission characteristics / EMI characteristics, in order transmission characteristics of the coaxial cable, by the stable contact realized by adopting gold-plated both on the bottom shell of the cable side connector and PCB connector ground terminals.

We are supplying value-added and highly original products to many

Board to Cable Connector

- Extra-fine coaxial cable type

- XSL series
- XSLs series
- USL series
- USLS series
- USLS21 series
- SSL series
- TSL series
- TMC series

- crimp cable type
- flat cable type
- interface type



Contact us

Application Note
(PDF)



FAQ 

J-Parc Experiment Case

Employed XSL Cables

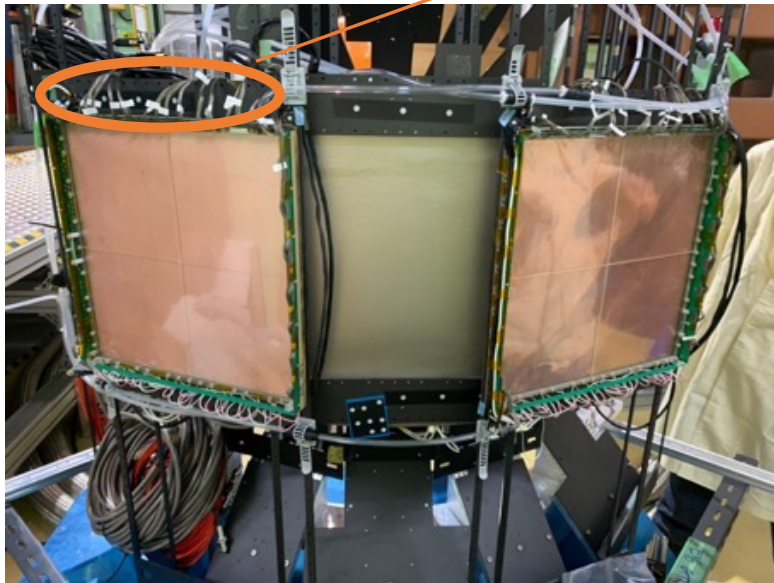

48 channels/Bundle

JPY10,000=US\$100/Bundle

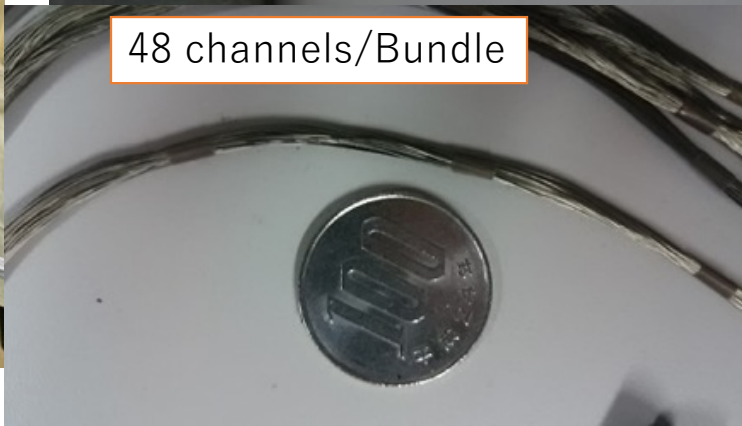

Why didn't we consider this option from the beginning?

INTT Readout Cable Chain

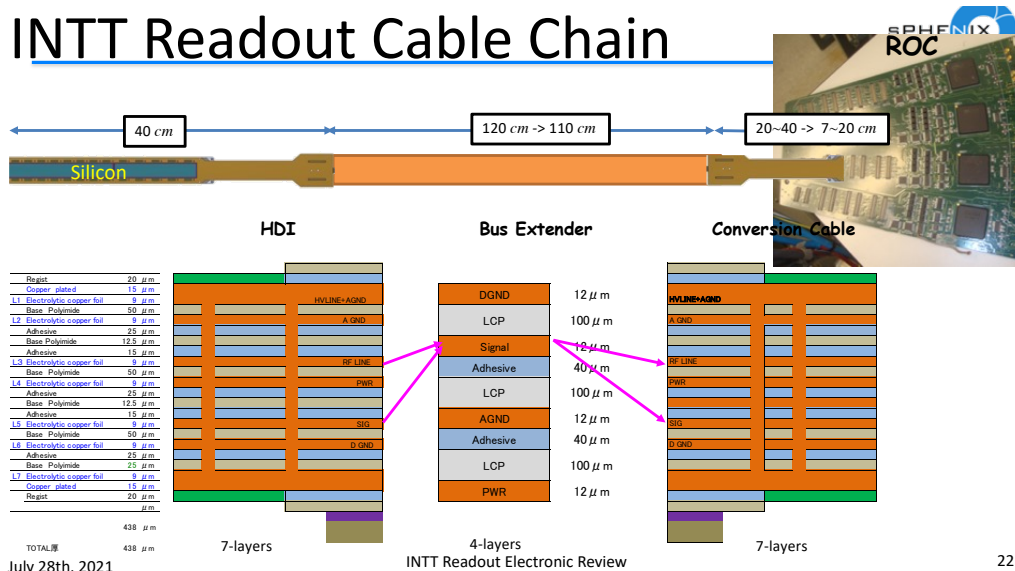

- Tried to reproduce the same structure with HDI for the efficient signal transmission.
- Tighter special condition in ROC end as well to accommodate 4 layers barrel design.

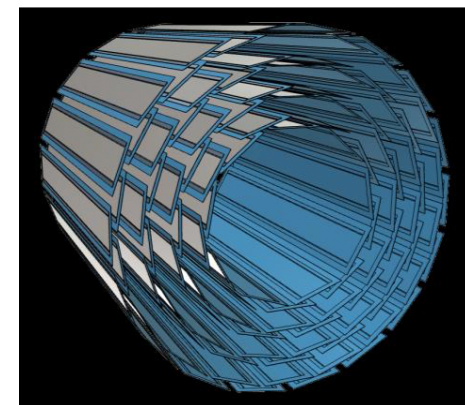



Backup Slides

Quick Cost Estimate

Number of Conversion cables per ladder	2		
Total Number of Ladders in INTT Barrel	56		
Length of Conversion Cable [m]	0.2		
Cost [/48channel]	¥10,000 (US\$100)		
Cost [/channel]	¥208		
	Per Conversion Cable	Per Ladder	Per Barrel
Number of Signal Lines per cable	200	400	22400
Total Cost (by bundle)	¥41,667	¥83,333	¥4,666,667
	\$379	\$758	\$42,424

US\$1 ~ JP¥110

OK, it reasonably fits to our budget.

XSL SERIES

0.25mm PITCH CONNECTOR FOR MICRO COAXIAL CABLE



FEATURES

- ▶ Compact connector with a low profile of 1.0 mm(0.039") and a mating width of 6 mm(0.236").
- ▶ For micro coaxial cable(#44 AWG, #46 AWG).
- ▶ Signal terminals are soldered by Pulse Heat in one shot and keep a stable & highly reliable connection.
- ▶ Equipped with a metal shell, noise reduction and product strength are ensured.
- ▶ Multiple ground terminals are provided for enhanced transmission characteristics and EMS protection.
- ▶ Highly reliable design with effective mating length of 0.51mm(0.020").

*Specially designed insertion jig, withdrawal jig, and caulking jig for a shell are also available.

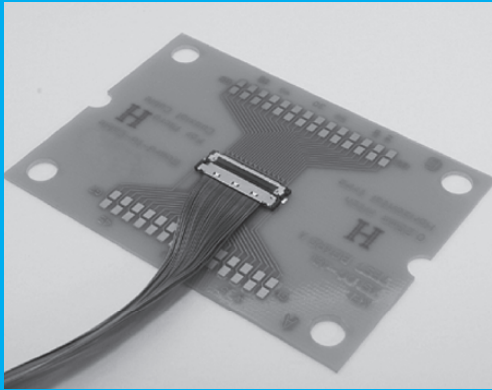

XSL Connector End

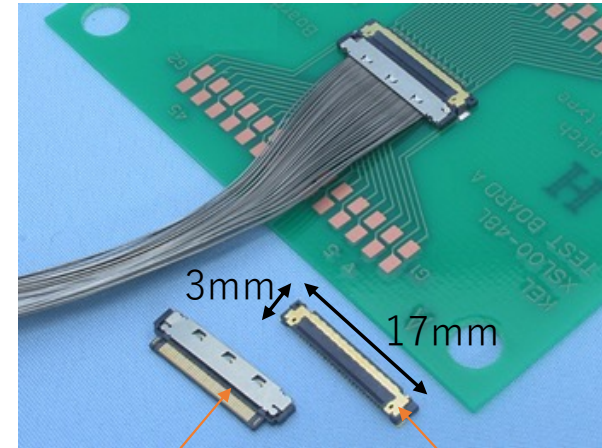

Cable end

Surface mount base on a circuit board

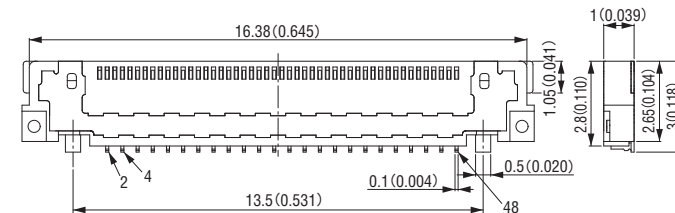

ORDER CODE

XSL00-48 L-

- ① ② ③ ④

*Please order in multiples of the quantity per package.

- ① **[Type]** XSL00 : Receptacle (PCB side connector)
- ② **[Number of contacts]** 48 : 48 pin
- ③ **[Contact tail style]** L : Right angle
- ④ **[Number of Packaging]** A : 500pcs. per reel B : 1,000pcs. per reel C : 3,000pcs. per reel

ORDER CODE

XSL20-48 S

- ① ② ③

*Please order in multiples of the quantity per package.

- ① **[Type]** XSL20 : Plug (Cable side connector)
- ② **[Number of contacts]** 48 : 48 pin
- ③ **[Cable exit style]** S : Straight

*Plug(cable side connector) is composed of a base and a shell.
The base is packed in tray (1,000pcs per box) and the shell is packed in embossed tape and reel (10,000pcs per reel),therefore MOQ of the plug is 10,000pcs.
Please contact your local KEL sales office for orders less than the MOQ 10,000pcs.

How many bundles are need per conv. cable?

100+100=200 pins per conversion cable.

ROC Side							
RECEPTACLE (TOP)							
J1 (out side)				J2 (in side)			
#	name (net)	#	name (net)	#	name (net)	#	name (net)
1	AGND	100	DGND	1	AGND	100	DGND
2	DS1_CP01_OUT1P	99	DS1_CP01_OUT0P	2	SC_IN1P	99	RESET1P
3	DS1_CP01_OUT1N	98	DS1_CP01_OUT0N	3	SC_IN1N	98	RESET1N
4	DS1_CP02_OUT1P	97	DS1_CP02_OUT0P	4	DGND	97	BCO_CLK1P
5	DS1_CP02_OUT1N	96	DS1_CP02_OUT0N	5	DGND	96	BCO_CLK1N
6	DS1_CP03_OUT1P	95	DS1_CP03_OUT0P	6	OUT_CLK1P	95	SC_OUT1P
7	DS1_CP03_OUT1N	94	DS1_CP03_OUT0N	7	OUT_CLK1N	94	SC_OUT1N
8	DS1_CP04_OUT1P	93	DS1_CP04_OUT0P	8	DGND	93	DGND
9	DS1_CP04_OUT1N	92	DS1_CP04_OUT0N	9	DGND	92	DGND
10	CAL_INJECT1	91	DGND	10	DS1_CP06_OUT1P	91	DS1_CP06_OUT0P
11	AGND	90	DGND	11	DS1_CP06_OUT1N	90	DS1_CP06_OUT0N
12	DS1_CP05_OUT1P	89	DS1_CP05_OUT0P	12	DS1_CP08_OUT1P	89	DS1_CP08_OUT0P
13	DS1_CP05_OUT1N	88	DS1_CP05_OUT0N	13	DS1_CP08_OUT1N	88	DS1_CP08_OUT0N
14	DS1_CP07_OUT1P	87	DS1_CP07_OUT0P	14	DS1_CP10_OUT1P	87	DS1_CP10_OUT0P
15	DS1_CP07_OUT1N	86	DS1_CP07_OUT0N	15	DS1_CP10_OUT1N	86	DS1_CP10_OUT0N
16	DS1_CP09_OUT1P	85	DS1_CP09_OUT0P	16	DS1_CP12_OUT1P	85	DS1_CP12_OUT0P
17	DS1_CP09_OUT1N	84	DS1_CP09_OUT0N	17	DS1_CP12_OUT1N	84	DS1_CP12_OUT0N
18	DS1_CP11_OUT1P	83	DS1_CP11_OUT0P	18	AGND	83	DGND
19	DS1_CP11_OUT1N	82	DS1_CP11_OUT0N	19	AGND	82	DGND
20	DS1_CP13_OUT1P	81	DS1_CP13_OUT0P	20	AGND	81	DGND
21	DS1_CP13_OUT1N	80	DS1_CP13_OUT0N	21	AGND	80	VDD(+2.5V)
22	AGND	79	DGND	22	AGND	79	VDD(+2.5V)
23	AGND	78	DGND	23	VA(+2.5V)	78	VDD(+2.5V)
24	VA(+2.5V)	77	VDD(+2.5V)	24	VA(+2.5V)	77	VDD(+2.5V)
25	VA(+2.5V)	76	VDD(+2.5V)	25	VA(+2.5V)	76	VDD(+2.5V)
26	VA(+2.5V)	75	VDD(+2.5V)	26	VA(+2.5V)	75	VDD(+2.5V)
27	VA(+2.5V)	74	VDD(+2.5V)	27	VA(+2.5V)	74	VDD(+2.5V)
28	AGND	73	DGND	28	VA(+2.5V)	73	VDD(+2.5V)
29	AGND	72	DGND	29	AGND	72	VDD(+2.5V)
30	DS0_CP13_OUT0N	71	DS0_CP13_OUT1N	30	AGND	71	VDD(+2.5V)
31	DS0_CP13_OUT0P	70	DS0_CP13_OUT1P	31	AGND	70	DGND
32	DS0_CP11_OUT0N	69	DS0_CP11_OUT1N	32	AGND	69	DGND
33	DS0_CP11_OUT0P	68	DS0_CP11_OUT1P	33	AGND	68	DGND
34	DS0_CP09_OUT0N	67	DS0_CP09_OUT1N	34	DS0_CP12_OUT1P	67	DS0_CP12_OUT1N
35	DS0_CP09_OUT0P	66	DS0_CP09_OUT1P	35	DS0_CP12_OUT1N	66	DS0_CP12_OUT1P
36	DS0_CP07_OUT0N	65	DS0_CP07_OUT1N	36	DS0_CP10_OUT1P	65	DS0_CP10_OUT1N
37	DS0_CP07_OUT0P	64	DS0_CP07_OUT1P	37	DS0_CP10_OUT1N	64	DS0_CP10_OUT1P
38	DS0_CP05_OUT0N	63	DS0_CP05_OUT1N	38	DS0_CP08_OUT1P	63	DS0_CP08_OUT1N
39	DS0_CP05_OUT0P	62	DS0_CP05_OUT1P	39	DS0_CP08_OUT1N	62	DS0_CP08_OUT1P
40	AGND	61	DGND	40	DS0_CP06_OUT1P	61	DS0_CP06_OUT1N
41	CAL_INJECT0	60	DGND	41	DS0_CP06_OUT1N	60	DS0_CP06_OUT1P
42	DS0_CP04_OUT0N	59	DS0_CP04_OUT1N	42	DGND	59	DGND
43	DS0_CP04_OUT0P	58	DS0_CP04_OUT1P	43	DGND	58	DGND
44	DS0_CP03_OUT0N	57	DS0_CP03_OUT1N	44	OUT_CLK0N	57	SC_OUT0P
45	DS0_CP03_OUT0P	56	DS0_CP03_OUT1P	45	OUT_CLK0P	56	SC_OUT0N
46	DS0_CP02_OUT0N	55	DS0_CP02_OUT1N	46	DGND	55	RESET0P
47	DS0_CP02_OUT0P	54	DS0_CP02_OUT1P	47	DGND	54	RESET0N
48	DS0_CP01_OUT0N	53	DS0_CP01_OUT1N	48	SC_IN0P	53	BCO_CLK0P
49	DS0_CP01_OUT0P	52	DS0_CP01_OUT1P	49	SC_IN0N	52	BCO_CLK0N
50	AGND	51	DGND	50	AGND	51	DGND

Category	# of Assigned Pins	Cu XS [μm^2]
Signal	124	1962
Analogue Power	12	
Digital Power	14	
DCOM	30	60,000
ACOM	20	40,000
Sum	200	

- Not yet clear if Micro-Coax are the best cables for GND and power lines. For now, let's just consider only signal pins.
- 3 bundles of 48 channel XSL cables covers 124 signal channels.



Micro-Coaxial Connectors



Search Micro-Coax/Discrete Wire

Download Catalog

I-PEX Micro-Coaxial Connectors

Alternative μ -CoAX Model

I-PEX® CARLINE® and EPL™ Micro-Coaxial Connectors are available in a wide range of configurations for applications including USB, Thunderbolt 3, eDP, HBR3, PCIe Gen 4

We use cookies and other tracking technologies to improve your browsing experience on our site to analyze traffic and understand where our audience is coming from. To find out more or to opt-out, please read our [Cookie Disclaimer](#). In addition, please read our [Privacy Policy](#). By choosing I ACCEPT, you consent to our use of cookies and other tracking technologies.

I ACCEPT

Coaxial cable structure

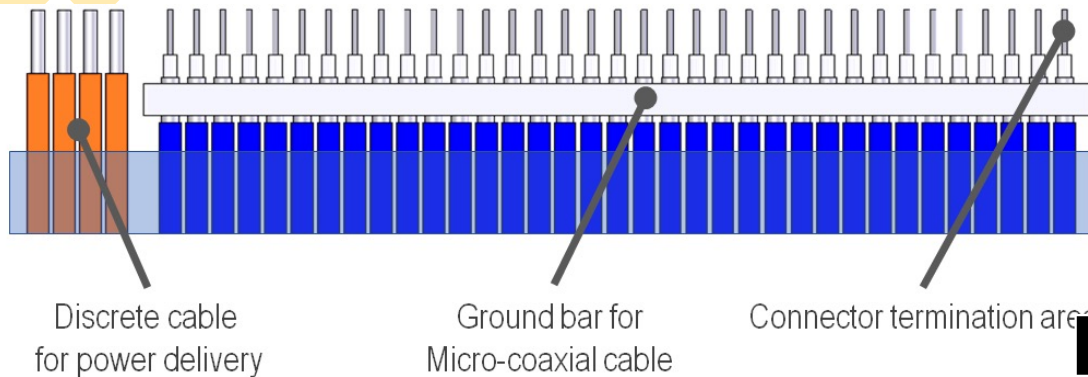
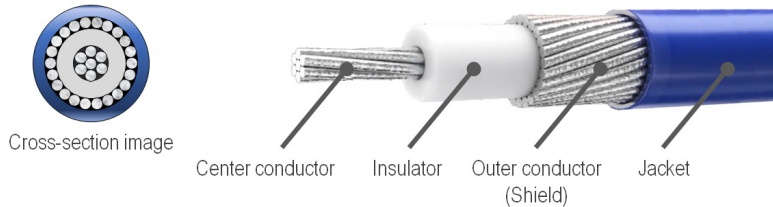

Discrete cable for power delivery

Ground bar for Micro-coaxial cable

Connector termination area

Discrete cable structure

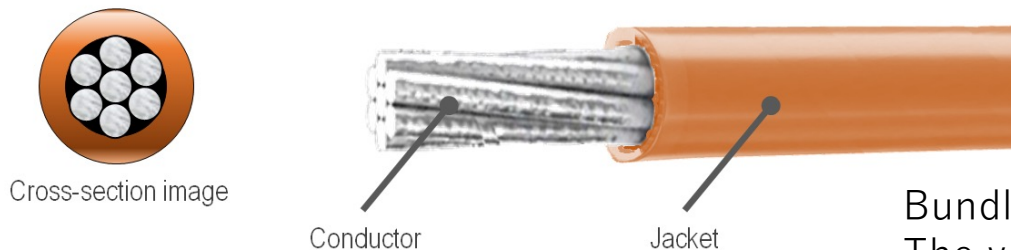

Cross-section image

Conductor

Jacket

GND/Power Lines

- Combine multiple μ -cables as a bundle.
- Can we customize the number of μ -cables to be bundled?

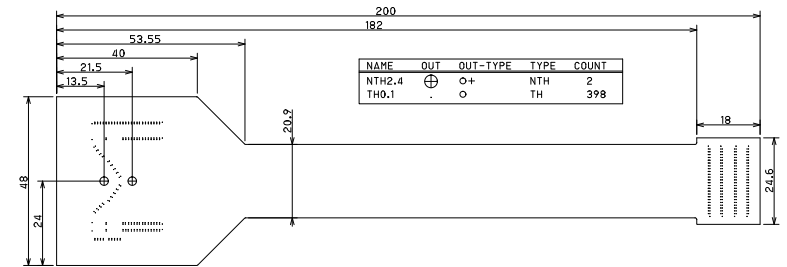

Category	# of Assigned Pins	Cu XS [μm^2]	FPC [μm^2]
Signal	124	1962	540
Analogue Power	12	24,000	100,000
Digital Power	14	28,000	100,000
DCOM	30	60,000	200,000
ACOM	20	40,000	200,000
Sum	200		

Bundled xs may establish about $\frac{1}{4}$ resistance compared to FPC. The voltage drop in power line may need careful attention.

How can we assemble XSL cables as a conversion cable?

Given the connector size, ROC end looks tight area budget.

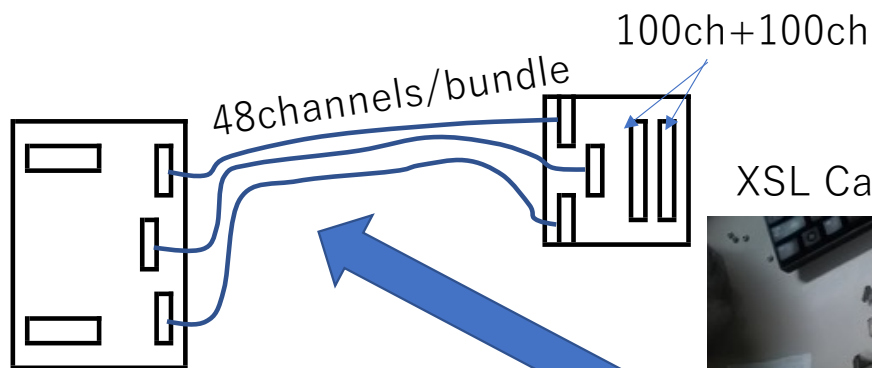
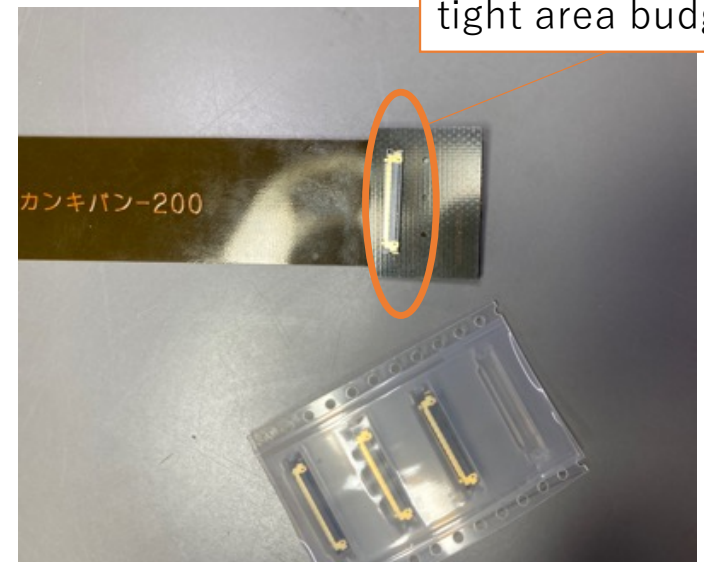
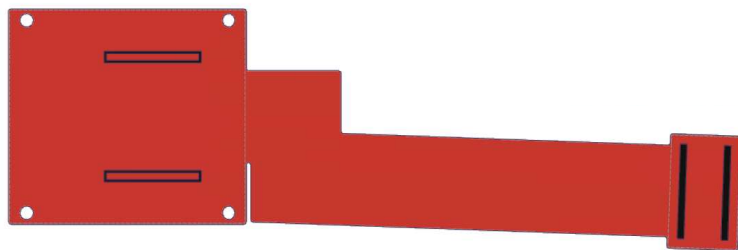

XSL Cables (48 channels/bundle)

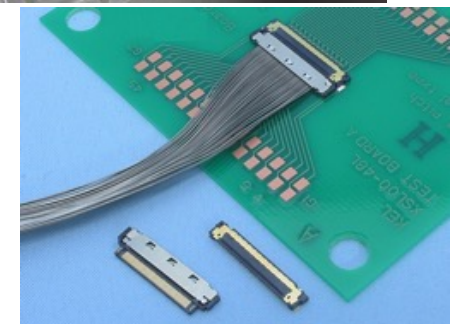

ROC End Connector Design Idea (1)

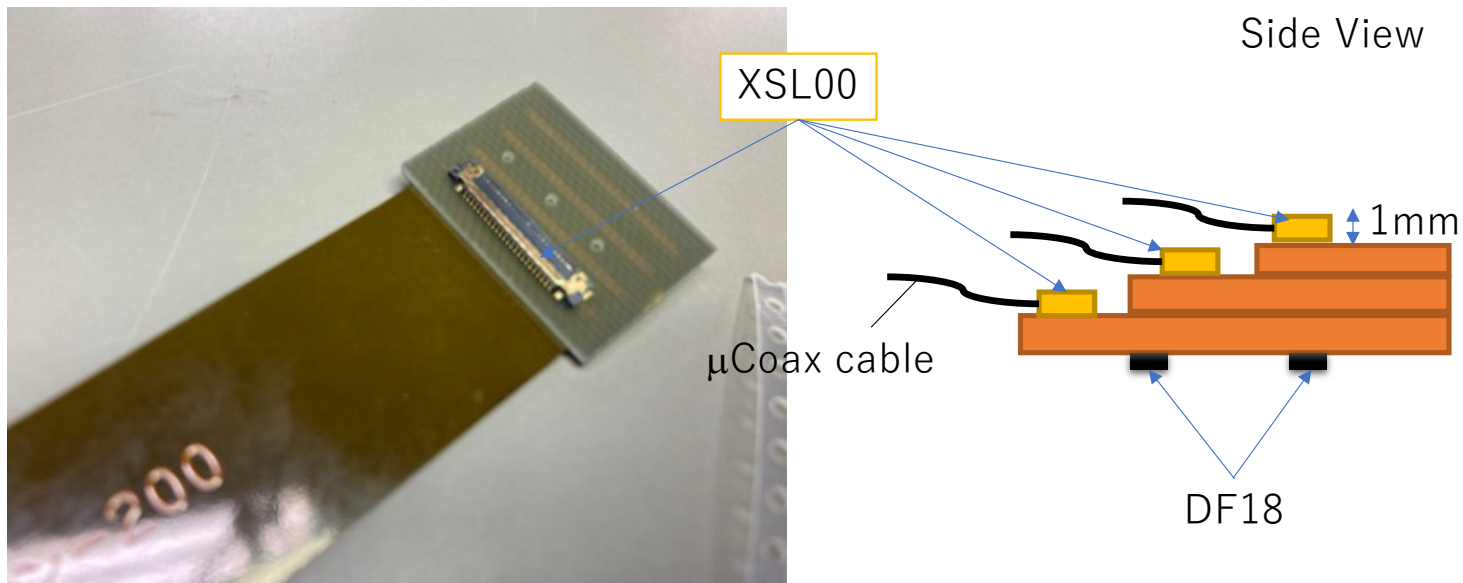

- 😊 Employ commercial connector (\$). Fit within the present G10 size
- 🤖 Too thick for thruholes. May be technically impossible)

ROC End Connector Design Idea (2)

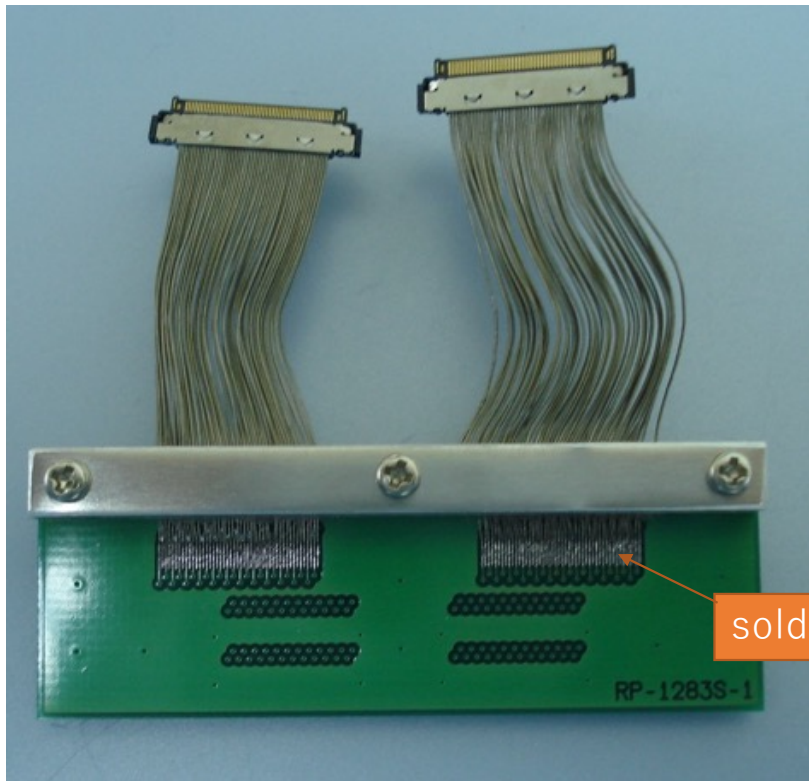

JPY100,000/board=US\$1,000/board

- Directly solder on the print circuit board. This is doable, but costly.
- Assuming 3 bundles/board, the cost is estimated JPY150,000/conversion cable (\$1,500).
- Approximately, JPY200,000k=US\$200k + Bus Extender side connectors for the production.
- It is not totally unreasonable, but relatively expensive solution.

😊 May fit within present G10 size.
🤖 Custom connection. Pricy solution (\$\$).

ROC End Connector Design Idea (3)

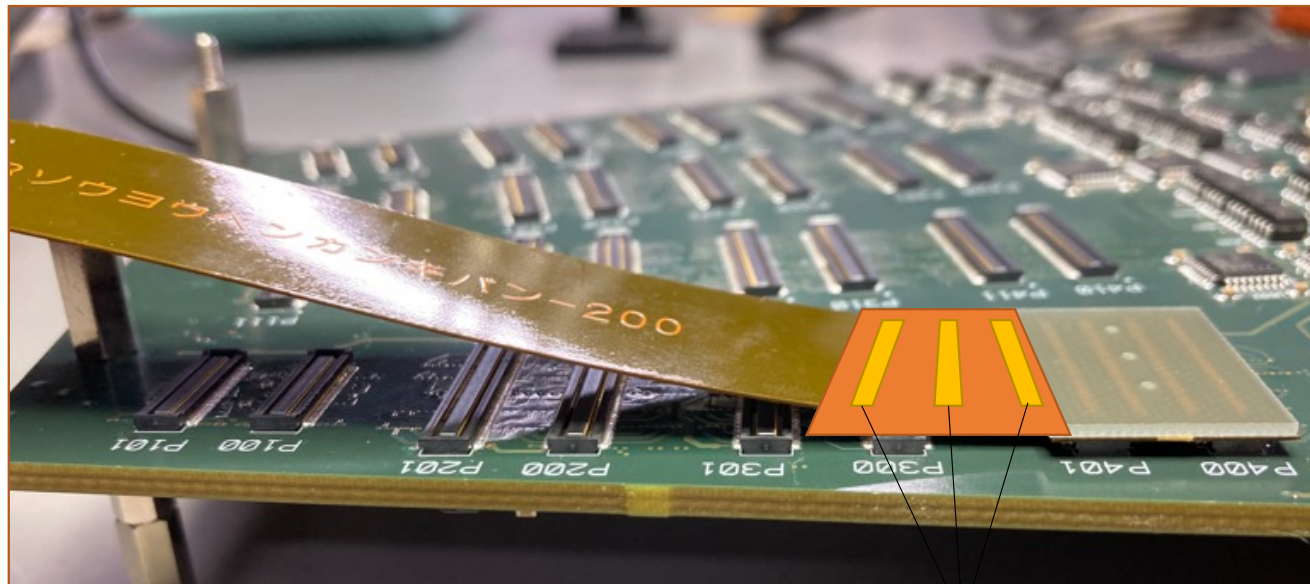

XSL00 connectors

- Extend the print circuit board end to accommodate XSL00 connectors.
- This will kill the P300 and P301 DF18 connectors, but P30x ports are planned to be open for a backup.

😊 Employ commercial connector product (\$).

🤖 Disable simultaneous use of adjacent row DF18 ports.

J-Parc Pre-Amp Design

XSL00 connector

- ボンディング保護カバー用ネジ穴 $\varnothing 17.500$ 3.500
- HDMI補強用ネジ穴 $\varnothing 17.500$

The distance between XSL00 connectors is secured 10mm

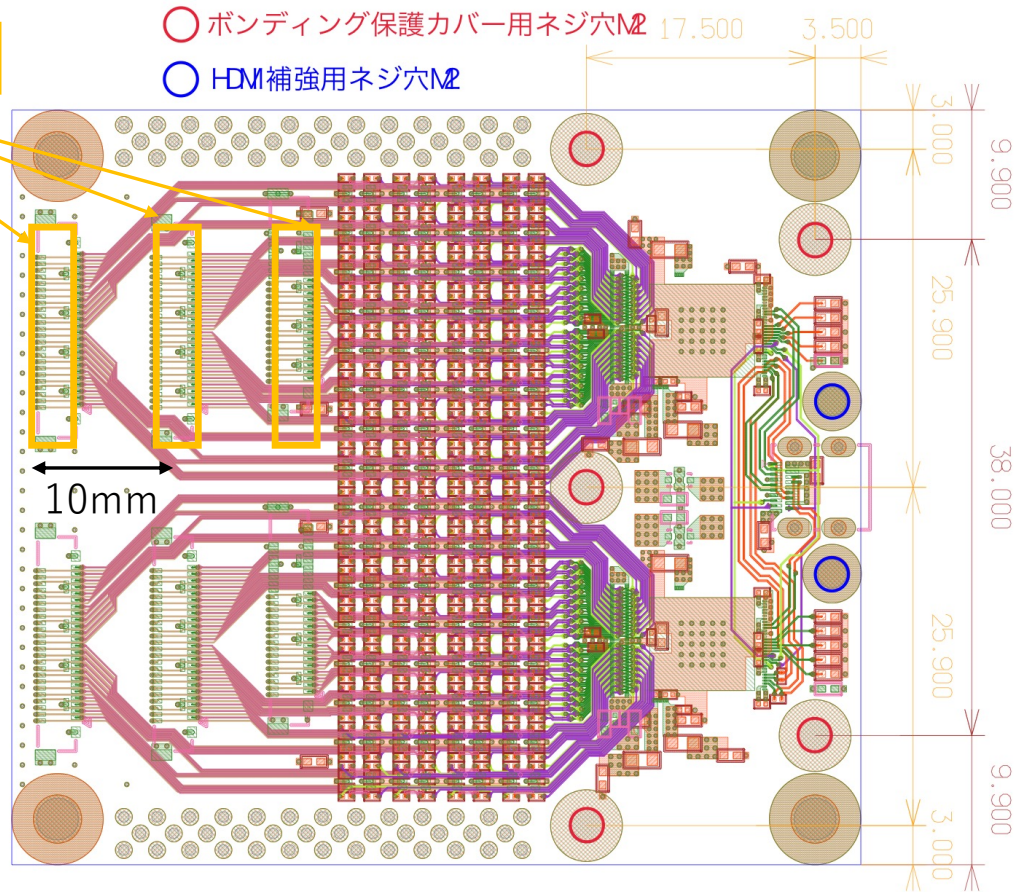

Backup

Material Cost Estimate

Number of Conversion cables per ladder	2		
Total Number of Ladders in INTT Barrel	56		
Length of Conversion Cable [m]	0.2		
Cost [/m]	¥13,000		
	Per Conversion Cable	Per Ladder	Per Barrel
Number of Signal Lines per cable	124	248	13888
Total Length [m]	24.8	49.6	2777.6
Total Cost	¥322,400	¥644,800	¥36,108,800